







Art. No: **HP10488**



-  Bolted on existing bolt/treads on balcony, or C-Bracket for exempel, precasted in balconies.
-  Use M12 bolt or M10 bolt with washer. (our c-brackets are M10).
-  Max c-c = 2.4m
-  Compatible with our slim posts or any other posts made by 35x35 tube.
-  Complies with EN13374 Class A.
-  Hot dip galvanized.
-  Weight: 1,1kg

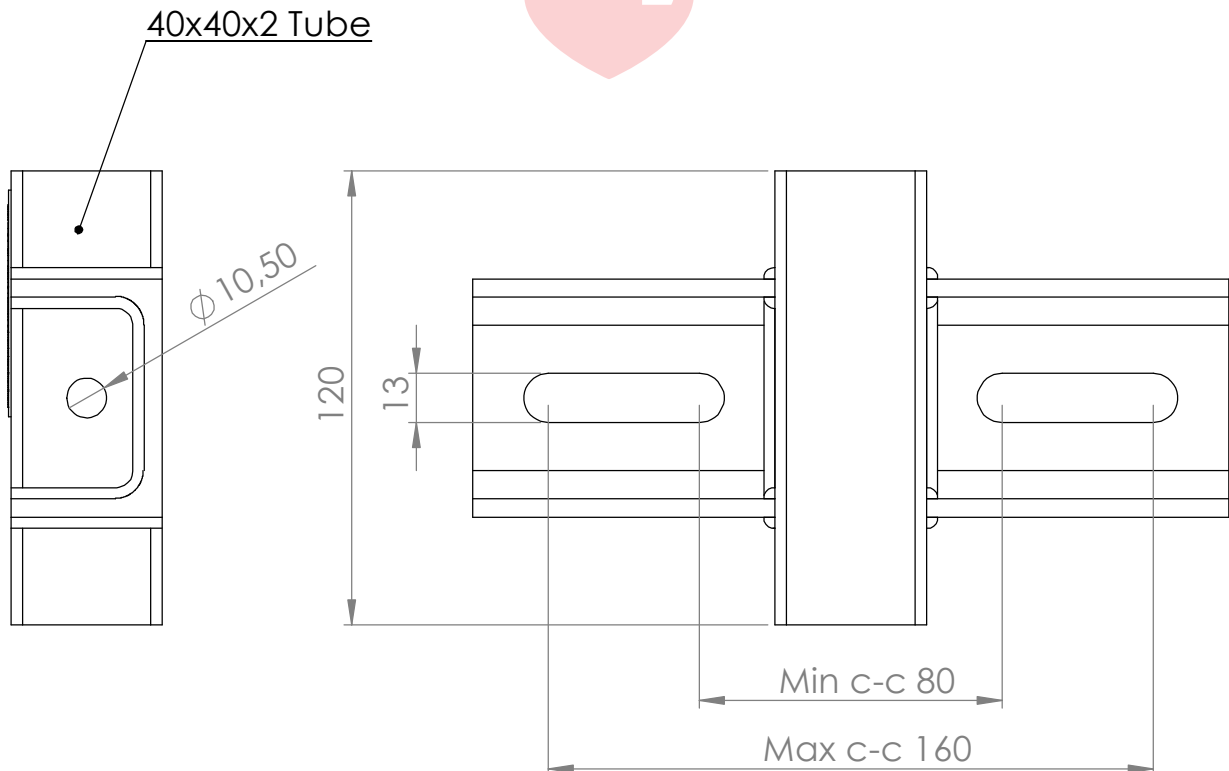

Delivered advantageously in steel box for brackets HP30557 (500pcs per basket).