









Art. No: **HP10754**

-  Angled bracket of 10° makes it possible to work on all the slab floor without removing edge protection.
-  Bolted on cast-in brackets (c-bracket) using M10 bolts or with expander min length 80mm c-c 100mm.
-  Use M10 bolts with washers.
-  Max C-C = 2,4m.
-  Complies with EN13374 Class A.
-  Hot dip galvanised.
-  **O.B.S.** as pre-order item in 90° (inserted image).
-  Weight: 1,9kg

10° HP10754



90° HP10755

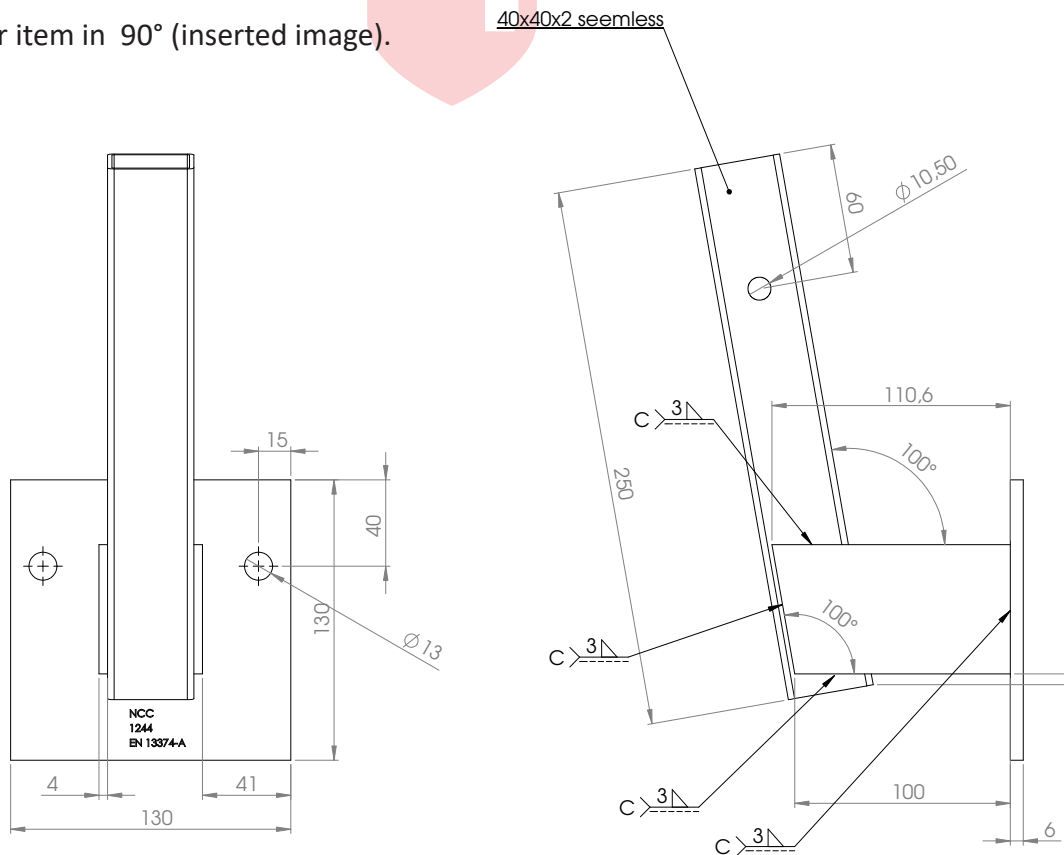

Delivered advantageously in steel box for brackets HP30557 (200pcs per basket).